

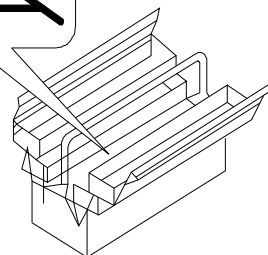

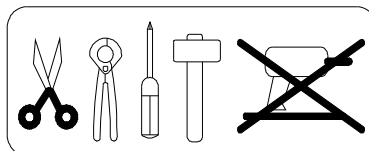

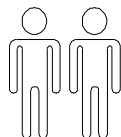





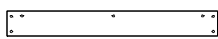
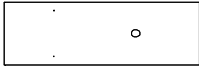

- |                                       |                                   |
|---------------------------------------|-----------------------------------|
| <b>D</b> Montageanleitung             | <b>GB</b> Assembly instructions   |
| <b>NL</b> Handleiding voor de montage | <b>PL</b> Instrukcja montazu      |
| <b>TR</b> Montaj talimati             | <b>RU</b> Инструкция по монтажу   |
| <b>FR</b> Notice de montage           | <b>IT</b> Istruzioni di montaggio |
| <b>CS</b> Montážní návod              | <b>SK</b> Návod na montáž         |
| <b>HU</b> Szerelési útmutató          | <b>RO</b> Instrucțiuni de montaj  |

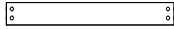
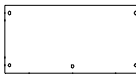

# SCWRLB

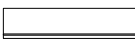
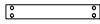
ITEM NO.	MEASUREMENT	QTY	SHAPE	CARTON NO.
①	1900 X 558 X 19	X1		1-3
②	1900 X 558 X 19	x1		1-3
③	1560 X 147 X 15	x2		2-3
④	1570 X 576 X 4	x1		2-3
⑤	1582 X 426 X 24	x2		2-3
⑥	860 X 530 X 15	x1		3-3
⑦	860 X 530 X 15	x1		3-3
⑧	860 X 100 X 15	x1		3-3
⑨	860 X 309 X 15	x1		3-3
⑩	854 X 220 X 15	x1		3-3
⑪	450 X 148 X 15	x1		3-3
⑫	450 X 148 X 15	x1		3-3
⑬	805 X 148 X 15	x1		3-3
⑭	434 X 80 X 15	x1		3-3
⑮	815 X 445 X 4	x1		3-3
⑯	860 X 505 X 15	x1		3-3

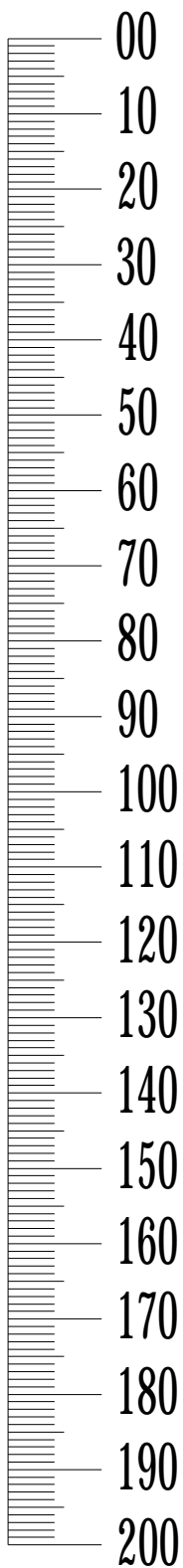

**Service • Asistenza • Dienstverlening • Serwis  
Servis • Szerviz • Сервисная служба**

Name • Nom • Nome • Naam • Nazwa • Jméno • Názov • Név • Denumire • Isim • Название		
Nr. • No. • N° • Номер • Číslo • Sz		
Тур • Type • Típus • Tipus • Típo • Тип		

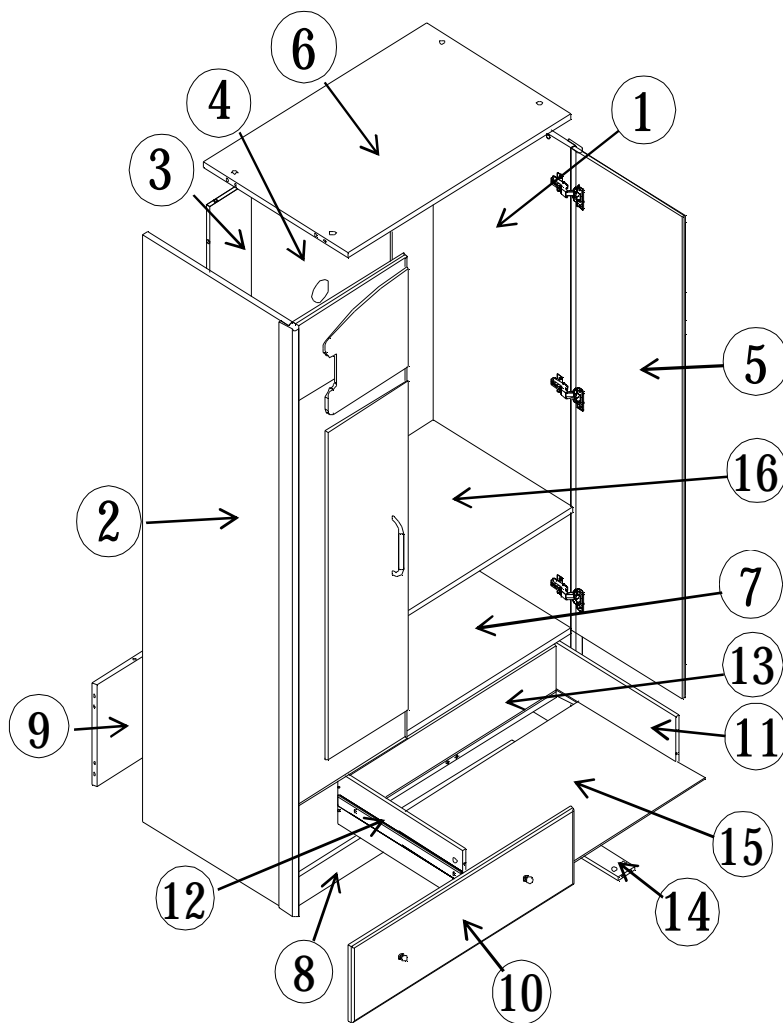

<b>A</b> x43	<b>B</b> x43	<b>C</b> 8x30 x18	<b>D</b> 4x20 x2	<b>D2</b> 4x25 x4	<b>E</b> 3.5x14 x48
<b>F</b> 3.5x20 x2	<b>F2</b> 3.5x35 x4	<b>G</b> x4	<b>H</b> x6	<b>I</b> x2	<b>J</b> x1
<b>K</b> 18D x1	<b>L</b> 60 x1	<b>M</b> x2	<b>N</b> x2		

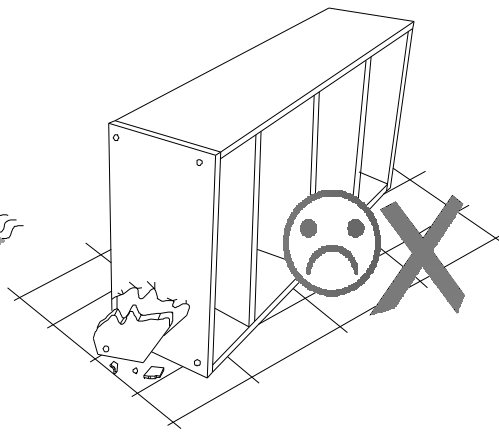
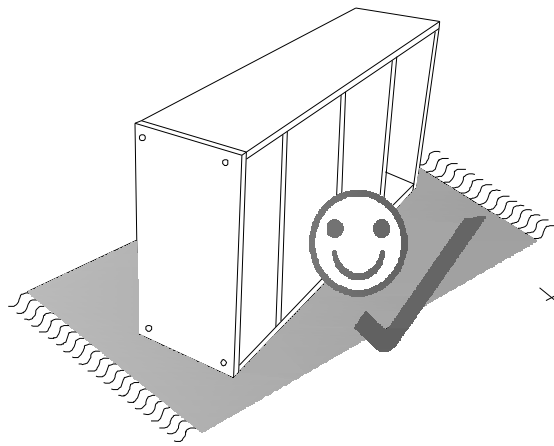

1

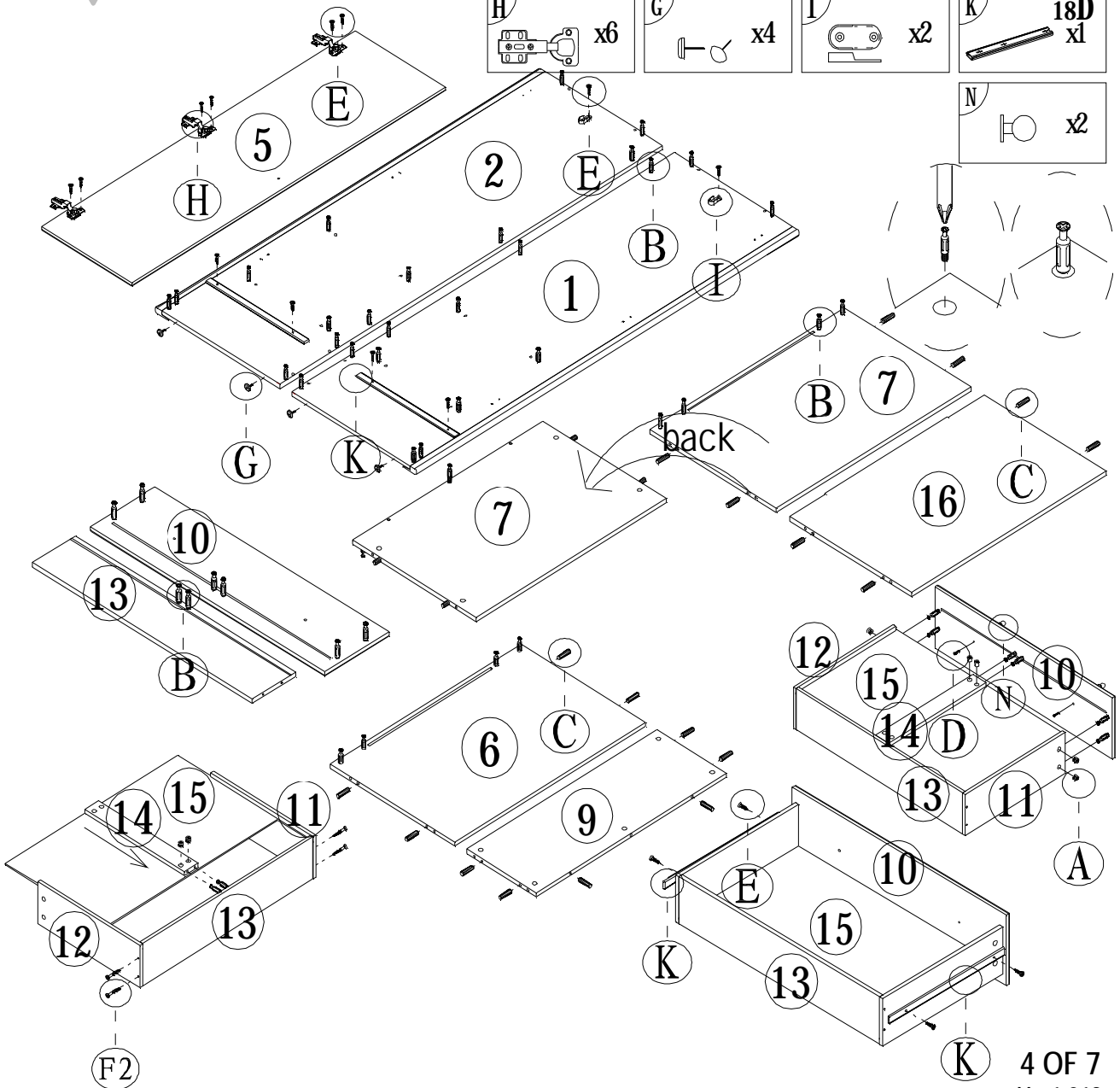
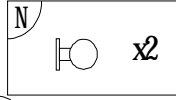
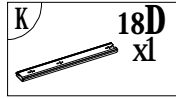
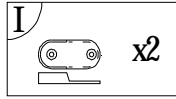
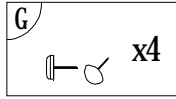
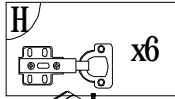
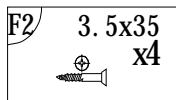
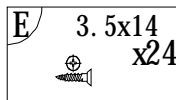
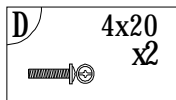
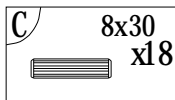
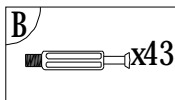
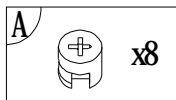

2

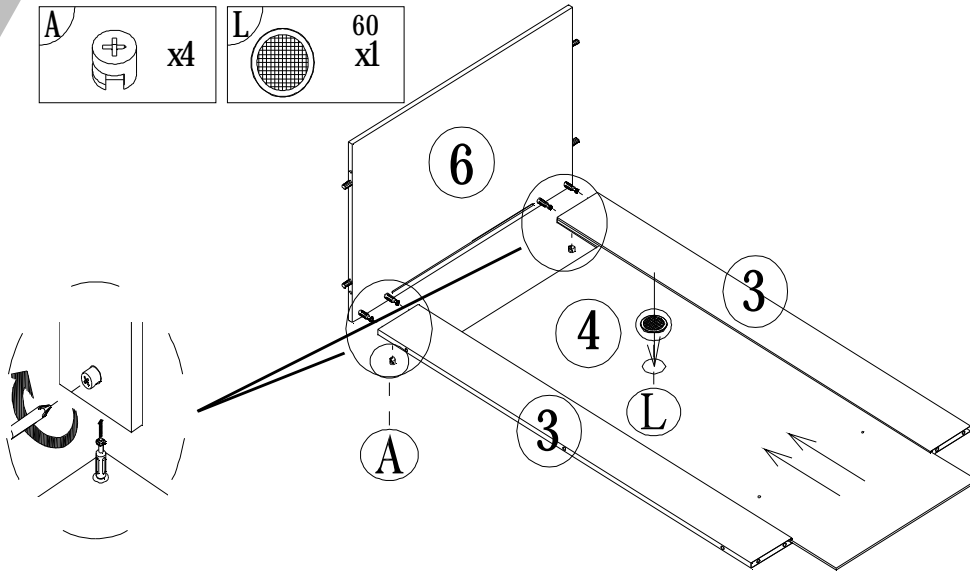
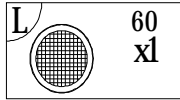
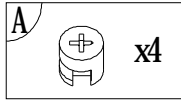

3

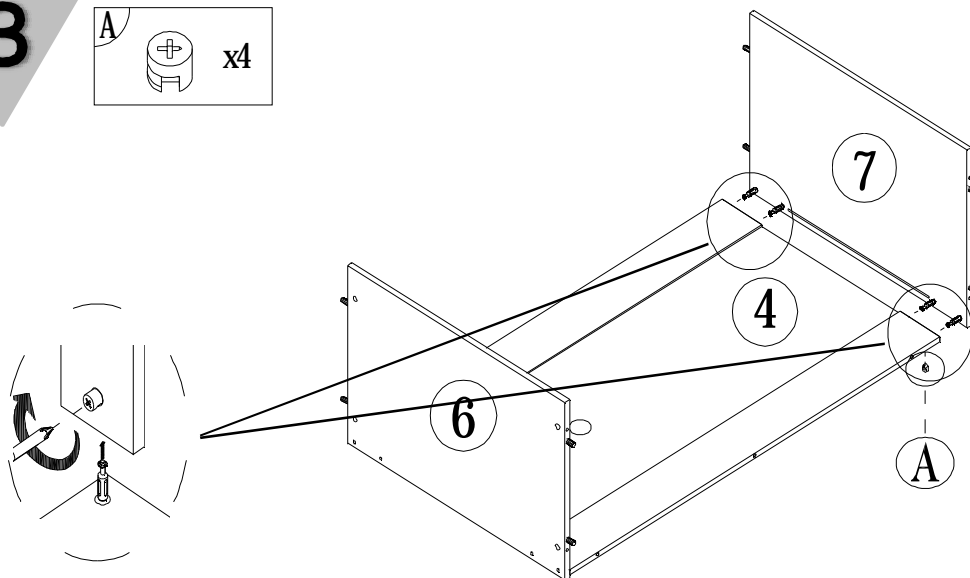
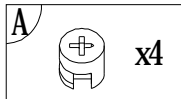

4

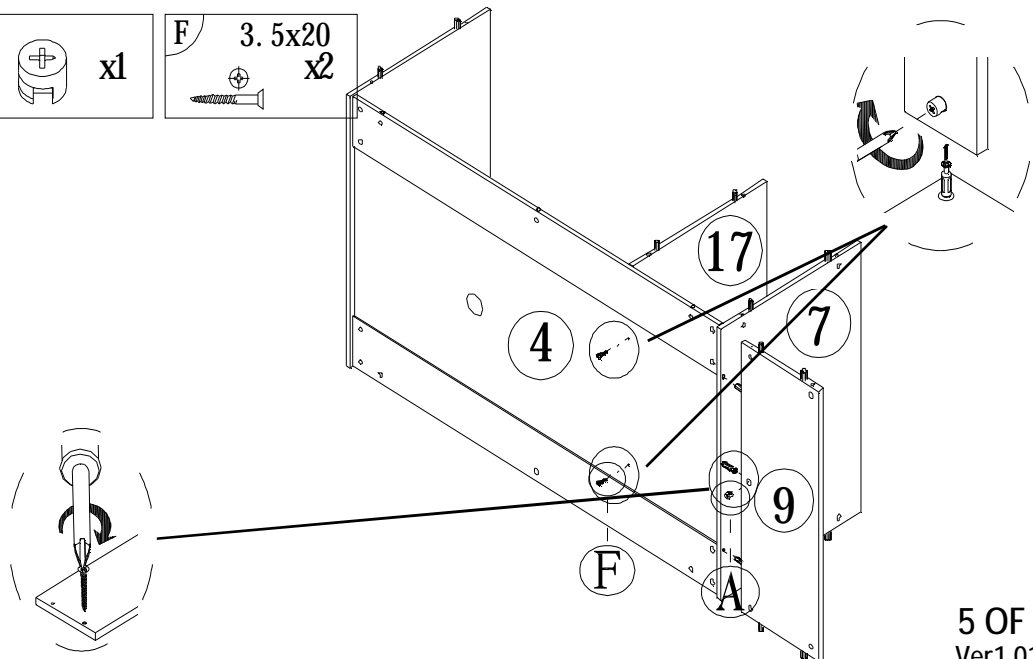
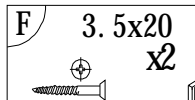
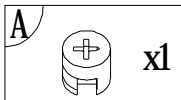

5

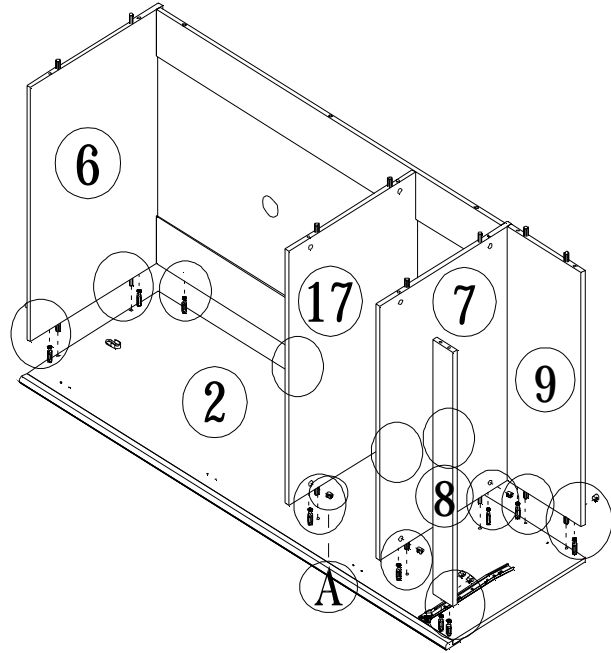
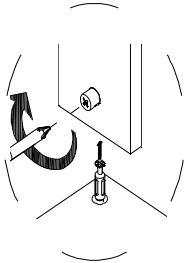
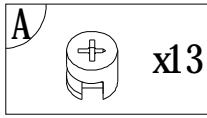

6

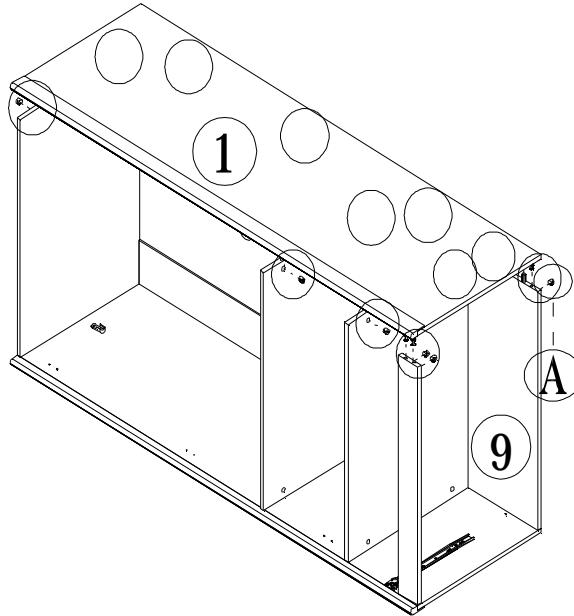
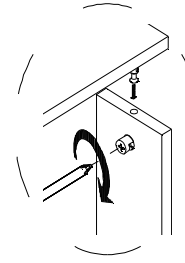
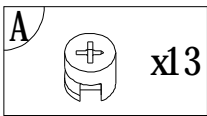

7

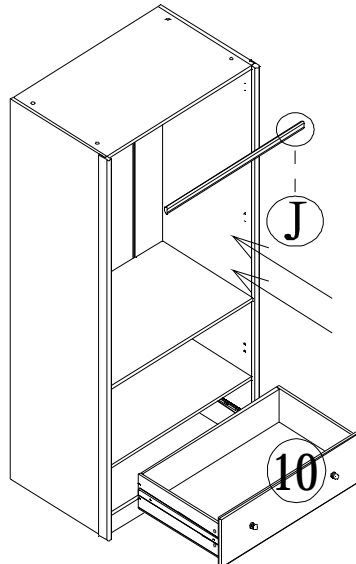
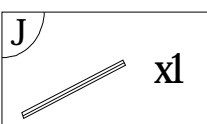

8

D2	4x25 x4	E	3.5x14 x24	M	x2
----	------------	---	---------------	---	----

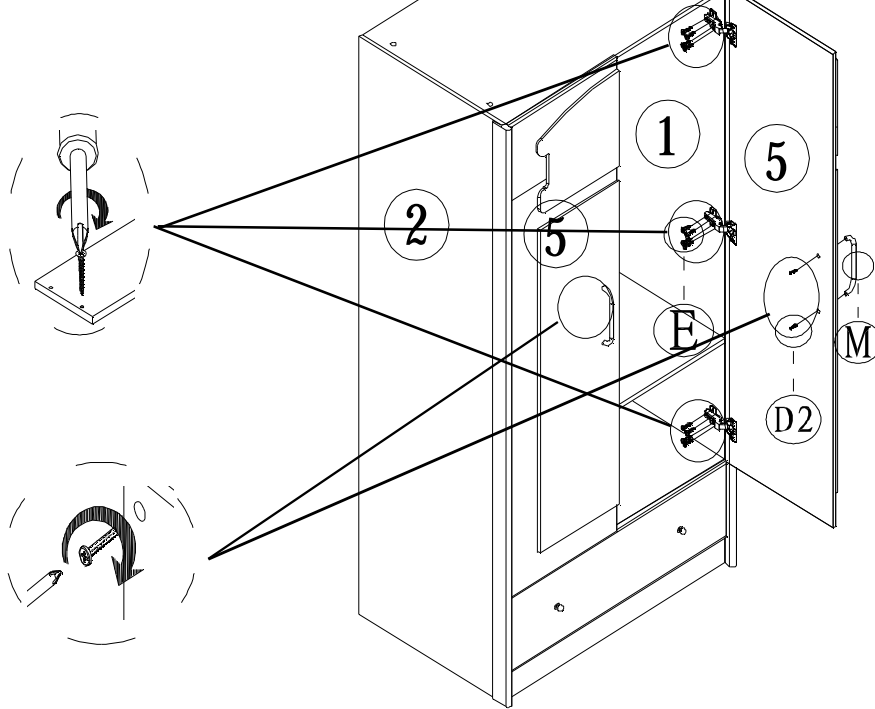

9

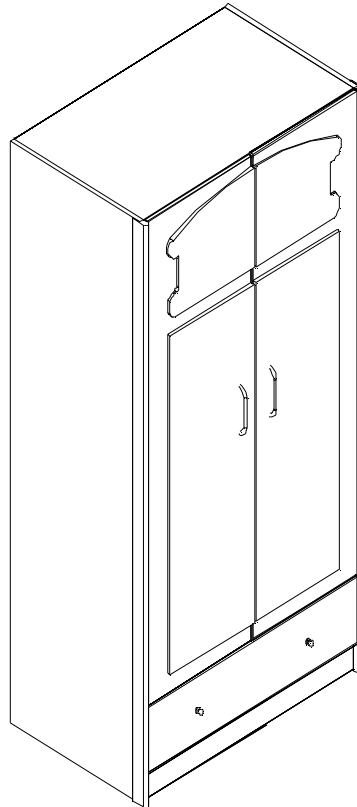

# Undetached Runner Instruction

